



# SENSORS FOR LOAD & TORQUE

---

 **PCB PIEZOTRONICS**  
AN AMPHENOL COMPANY

pcb.com | 1 800 828 8840



## LOAD CELLS

PCB® load cells address many force measurement, monitoring and control requirements in laboratory testing, industrial, and process control applications. All models utilize strain gages, which are configured into a Wheatstone bridge circuit as their primary sensing element, along with temperature and pressure compensation. A variety of configurations and capacities address a wide range of installation scenarios. Fatigue-rated load cells are offered for applications where high cyclic loads are being monitored, such as with fatigue testing machines or repetitive processes.

General purpose load cells are suitable for a wide range of general force measurement applications, including weighing, dynamometer testing, and material testing machines. Most of these designs operate in both tension and compression, and offer excellent accuracy and value.



GENERAL PURPOSE CANISTER LOAD CELL					
Model Number	1102-05A	1102-01A	1102-02A	1102-03A	1102-04A
Sensitivity	2 mV/V	2 mV/V	2 mV/V	2 mV/V	2 mV/V
Measurement Range	25 lb	50 lb	100 lb	200 lb	300 lb
Overload Limit	37.5 lb	75 lb	150 lb	300 lb	450 lb
Resonant Frequency	2.10 kHz	2.8 kHz	3.8 kHz	5.4 kHz	7.0 kHz
Non-Linearity	≤0.05 % FS	≤0.05 % FS	≤0.05 % FS	≤0.05 % FS	≤0.05 % FS
Hysteresis	≤0.05 % FS	≤0.05 % FS	≤0.05 % FS	≤0.05 % FS	≤0.05 % FS
Typical Applications	Weighing, component testing, quality control, material testing, seat testing, torque arm				



GENERAL PURPOSE LOW PROFILE LOAD CELL							
Model Number	1203-11A/084A100	1203-12A/084A100	1203-13A/084A100	1203-14A/084A100	1203-15A/084A100	1204-12A/084A101	1204-13A/084A101
Sensitivity	2 mV/V	2 mV/V	2 mV/V	4 mV/V	4 mV/V	4 mV/V	4 mV/V
Measurement Range	500 lb	1,000 lb	2,000 lb	5,000 lb	10,000 lb	25,000	50,000
Overload Limit	750 lbf	1,500 lb	3,000 lb	7,500 lb	15,000 lb	37,000	75,000
Resonant Frequency	2.35 kHz	3.5 kHz	5.5 kHz	7 kHz	10 kHz	12 kHz	15 kHz
Non-Linearity	≤0.04 % FS	≤0.04 % FS	≤0.04 % FS	≤0.05 % FS	≤0.05 % FS	≤0.05 % FS	≤0.05 % FS
Hysteresis	≤0.03 % FS	≤0.03 % FS	≤0.03 % FS	≤0.05 % FS	≤0.05 % FS	≤0.06 % FS	≤0.06 % FS
Typical Applications	Bumper impact, component testing, material testing, life cycle testing, structural testing, press applications						

Note: Standard "A" models feature a PT connector, but "B" models featuring a PC connector are available.

Note: Included mounting base insures proper performance in both tension and compression

Fatigue-rated load cells are specifically designed for fatigue testing machine manufacturers, or in any application where high cyclic loads are present. Applications include material testing, component life cycle testing, and structural testing. All fatigue-rated load cells are guaranteed against fatigue failure for 100 million fully reversed cycles.

These rugged load cells are manufactured using premium, fatigue-resistant, heat-treated steels. Internal flexures are carefully designed to eliminate stress concentration areas. Close attention is paid to the proper selection and installation of internal strain gages and wiring to ensure maximum life.



FATIGUE RATED LOW PROFILE LOAD CELLS						
Model Number	1403-11A/084A100	1403-12A/084A100	1403-13A/084A100	1403-14A/084A100	1404-12A/084A101	1404-13A/084A101
Sensitivity	1 mV/V	1 mV/V	1 mV/V	2 mV/V	2 mV/V	2 mV/V
Measurement Range	250 lbf	500 lbf	1,000 lbf	2,500 lbf	12,500 lbf	25,000 lbf
Overload Limit	750 lbf	1,500 lbf	3,000 lbf	7,500 lbf	37,500 lbf	75,000 lbf
Resonant Frequency	2.4 kHz	3.5 kHz	5.5 kHz	7.0 kHz	8.0 kHz	8.0 kHz
Non-Linearity	≤0.04 % FS	≤0.04 % FS	≤0.04 % FS	≤0.04 % FS	≤0.05 % FS	≤0.05 % FS
Hysteresis	≤0.03 % FS	≤0.03 % FS	≤0.03 % FS	≤0.04 % FS	≤0.05 % FS	≤0.05 % FS
Typical Applications	Calibration standard, component testing, material testing, structural testing, life cycle testing, torque arm					



FATIGUE RATED LOW PROFILE DUAL BRIDGE LOAD CELLS					
Model Number	1403-05ADB	1404-02ADB	1404-03ADB	1408-02ADB	1411-02ADB
Sensitivity	2 mV/V	2 mV/V	2 mV/V	2 mV/V	2 mV/V
Measurement Range	5,000 lbf	12,500 lbf	25,000 lbf	50,000 lbf	100,000 lbf
Overload Limit	15,000 lbf	37,500 lbf	75,000 lbf	150,000 lbf	300,000 lbf
Resonant Frequency	10 kHz	12 kHz	15 kHz	18 kHz	18 kHz
Non-Linearity	≤0.04 % FS	≤0.05 % FS	≤0.05 % FS	≤0.05 % FS	≤0.06 % FS
Hysteresis	≤0.04 % FS	≤0.05 % FS	≤0.05 % FS	≤0.05 % FS	≤0.06 % FS
Typical Applications	Calibration standard, component testing, material testing, structural testing, life cycle testing, torque arm				

Note: Standard "A" models feature a PT connector, but "B" models featuring a PC connector are available.

ROD END LOAD CELL						
Model Number	1380-01A	1380-02A	1380-03A	1381-01A	1381-02A	1381-04A
Sensitivity	2 mV/V	2 mV/V	2 mV/V	2 mV/V	2 mV/V	2 mV/V
Measurement Range	500 lbf	1,000 lbf	2,000 lbf	5,000 lbf	10,000 lbf	20,000 lbf
Overload Limit	750 lbf	1,500 lbf	3,000 lbf	7,500 lbf	15,000 lbf	30,000 lbf
Resonant Frequency	9 kHz	10 kHz	9 kHz	10 kHz	9 kHz	15 kHz
Non-Linearity	≤0.25 % FS	≤0.25 % FS	≤0.25 % FS	≤0.25 % FS	≤0.25 % FS	≤0.25 % FS
Hysteresis	≤0.15 % FS	≤0.15 % FS	≤0.15 % FS	≤0.15 % FS	≤0.15 % FS	≤0.15 % FS
Typical Applications	Designed for integration into tension measurement applications such as process automation, quality assurance, and production monitoring					



S-TYPE LOAD CELL							
Model Number	1630-03C	1630-04C	1630-06C	1631-01C	1631-03C	1631-04C	1631-06C
Sensitivity	2 mV/V	2 mV/V	2 mV/V	2 mV/V	2 mV/V	2 mV/V	2 mV/V
Measurement Range	50 lb	100 lb	250 lb	500 lb	1,000 lb	2,000 lb	5,000 lb
Overload Limit	75 lb	150 lb	375 lb	750 lb	1,500 lb	3,000 lb	7,500 lb
Resonant Frequency	1.5 kHz	1.8 kHz	2.2 kHz	2.2 kHz	3.2 kHz	2.4 kHz	2.5 kHz
Non-Linearity	≤0.05 % FS	≤0.05 % FS	≤0.05 % FS	≤0.05 % FS	≤0.05 % FS	≤0.05 % FS	≤0.05 % FS
Hysteresis	≤0.03 % FS	≤0.03 % FS	≤0.03 % FS	≤0.03 % FS	≤0.03 % FS	≤0.03 % FS	≤0.03 % FS
Typical Applications	Weighing, material testing, tensile test machines, assembly forces, general force measurements						





## TORQUE SENSORS

---

Torque sensors manufactured by PCB fall into two categories of measurement; reaction torque and rotational torque. Both styles utilize strain gages, which are configured into a Wheatstone bridge circuit, as their primary sensing element. Accuracies are typically within 0.1% and optional speed sensors permit additional measurement of rotational speed (RPM) and horsepower calculations.

Reaction torque sensors convert the torque applied to a fixed sensor into a usable measurement signal. These sensors are machined from a single piece of rigid steel that is instrumented with strain gauges in a Wheatstone bridge circuit. They have no moving parts and are typically flange mounted into a fixed position. Their output signal varies proportionally to an applied torsional force. Examples of reaction torque applications include automotive brake testing, dynamometer testing, and bearing friction and lubrication studies. Rotational, or rotary, torque sensors typically measure the torque generated by rotating devices such as electric motors, automotive engines, transmissions, pumps, and compressors.

Rotary torque sensors employ a freely rotating shaft within a fixed housing. The shaft is instrumented with strain gages in a Wheatstone bridge circuit. A non-contact rotary transformer facilitates electrical connection to the rotating strain gages. When installed, the rotating shaft becomes a coupling between a driving mechanism and an absorber or load. As the shaft is torsionally stressed, a proportional change in the output signal is observed. Changes in rotational speed and load affect the torque that is measured. Advantages of the rotary transformer approach include less maintenance and less signal noise than older slip-ring designs. Applications for rotary torque sensors include electric motor testing, automotive engine testing, dynamometer testing, drive train measurements, and gearbox testing.

The TORKDISC<sup>®</sup> represents a newer approach to rotary torque measurements. Rather than slip-rings or rotary transformers, the TORKDISC<sup>®</sup> contains a miniature, 16-bit digital telemetry transmitter. Digitized measurement signals are picked up by a circumferential antenna and relayed to a receiver unit where they are conditioned to a voltage output signal. Advantages include smaller sensor size and noise-free, digital signal transmission.





## REACTION TORQUE SENSORS

Reaction torque sensors are suitable for a wide array of torque measurement applications. They are typically used in torsional test machines, motor dynamometers. Motion should be limited to 20° or less to prevent damage to cabling. Due to the fact that these sensors do not utilize bearings, slip-rings, or other rotating elements, their installation and use can be very cost effective.

The rigid sensor mechanically resists rotation and will experience a torsional stress in response to an applied torsional force. This stress causes a proportional resistance change to occur in the strain gages, resulting in a voltage shift in the sensor's output signal. You might consider a reaction torque sensor to be similar to a pickle jar with a tight lid. As you try to twist the lid of the jar, the reaction torque experienced by the jar increases until the lid becomes loosened.



Reaction torque sensors are particularly useful in applications where the introduction of inertia due to a rotating mass between the driver motor and driven load is undesirable.

An example of this can be found in small motor testing, where introduction of a rotating mass between the motor and load device will result in an error during acceleration. For these applications, the reaction torque sensor can be used between the driver motor, or driven load, and ground. An added benefit is that such an installation is not limited in RPM by the torque sensor.

REACTION TORQUE SENSOR					
Model Number	2508-01A	2508-02A	2508-03A	2508-04A	2508-05A
Sensitivity	2 mV/V	2 mV/V	2 mV/V	2 mV/V	2 mV/V
Measurement Range	50 lbf-in	100 lbf-in	200 lbf-in	500 lbf-in	1,000 lbf-in
Overload Limit (Axial Thrust)	200 lbf	280 lbf	400 lbf	500 lbf	660 lbf
Maximum Torque	75 lbf-in	150 lbf-in	300 lbf-in	750 lbf-in	1,500 lbf-in
Torsional Stiffness	2,350 lbf-in/radian	6,700 lbf-in/radian	18.8 klbf-in/radian	73 klbf-in/radian	127 klbf-in/radian
Resonant Frequency	380 kHz	620 kHz	1,040 kHz	2,050 Hz	2,700 Hz
Non-Linearity	≤0.10 % FS	≤0.10 % FS	≤0.10 % FS	≤0.10 % FS	≤0.10 % FS
Hysteresis	≤0.10 % FS	≤0.10 % FS	≤0.10 % FS	≤0.10 % FS	≤0.10 % FS
Typical Applications	Torsional test machines, motor dynamometers or any application where rotation is limited to less than 360°				

REACTION TORQUE SENSOR						
Model Number	2301-01A	2301-02A	2302-01A	2302-02A	2303-01A	2303-02A
Sensitivity	2 mV/V	2 mV/V	2 mV/V	2 mV/V	2 mV/V	2 mV/V
Measurement Range	2,000 lbf-in	5,000 lbf-in	10,000 lbf-in	20,000 lbf-in	50,000 lbf-in	100,000 lbf-in
Overload Limit (Axial Thrust)	2,000 lbf	5,000 lbf	10,000 lbf	20,000 lbf	50,000 lbf	100,000 lbf
Maximum Torque	3,000 lbf-in	7,500 lbf-in	15,000 lbf-in	30,000 lbf-in	75,000 lbf-in	150,000 lbf-in
Torsional Stiffness	370 klbf-in/radian	1,290 klbf-in/radian	2,980 klbf-in/radian	7,500 klbf-in/radian	10,200 klbf-in/radian	25,700 klbf-in/radian
Resonant Frequency	1 kHz	1.8 kHz	1.4 kHz	2.2 kHz	750 Hz	1.25 kHz
Non-Linearity	≤0.10 % FS	≤0.10 % FS	≤0.10 % FS	≤0.10 % FS	≤0.10 % FS	≤0.10 % FS
Hysteresis	≤0.10 % FS	≤0.10 % FS	≤0.10 % FS	≤0.10 % FS	≤0.10 % FS	≤0.10 % FS
Typical Applications	Torsional test machines, motor dynamometers or any application where rotation is limited to less than 360°					

REACTION TORQUE SENSOR				
Model Number	2304-01A	2304-02A	2305-01A	2305-02A
Sensitivity	2 mV/V	2 mV/V	2 mV/V	2 mV/V
Measurement Range	100,000 lbf-in	200,000 lbf-in	300,000 lbf-in	500,000 lbf-in
Overload Limit (Axial Thrust)	100,000 lbf	200,000 lbf	300,000 lbf	500,000 lbf
Maximum Torque	150,000 lbf-in	300,000 lbf-in	450,000 lbf-in	750,000 lbf-in
Torsional Stiffness	21,400 klbf-in/radian	53,900 klbf-in/radian	75,800 klbf-in/radian	150,000 klbf-in/radian
Resonant Frequency	690 kHz	1.1 kHz	560 Hz	1.25 kHz
Non-Linearity	≤0.10 % FS	≤0.10 % FS	≤0.10 % FS	≤0.10 % FS
Hysteresis	≤0.10 % FS	≤0.10 % FS	≤0.10 % FS	≤0.10 % FS
Typical Applications	Torsional test machines, motor dynamometers or any application where rotation is limited to less than 360°			





ROTARY TRANSFORMER				
Model Number	4115A-02A	4115A-03A	4115A-04A	4115A-05A
Sensitivity	2.5 mV/V	2.5 mV/V	2.5 mV/V	2.5 mV/V
Measurement Range	100 in-lb	200 in-lb	500 in-lb	1,000 in-lb
Maximum Speed	15,000 RPM	15,000 RPM	15,000 RPM	15,000 RPM
Overload Limit	300 in-lb	600 in-lb	1,500 in-lb	1,500 in-lb
Torsional Stiffness	13,500 in-lb/radian	33,000 in-lb/radian	94,000 in-lb/radian	94,000 in-lb/radian
Non-Linearity	≤0.05 % FS	≤0.05 % FS	≤0.05 % FS	≤0.05 % FS
Hysteresis	≤0.05 % FS	≤0.05 % FS	≤0.05 % FS	≤0.05 % FS
Typical Applications	Well-suited for higher speed operation in demanding test and measurement applications			

ROTARY TRANSFORMER						
Model Number	4115K-02A	4115K-03A	4115K-04A	4115K-05A	4115K-06A	4115K-07A
Sensitivity	2.5 mV/V	2.5 mV/V	2.5 mV/V	2.5 mV/V	2.5 mV/V	2.5 mV/V
Measurement Range	100 in-lb	200 in-lb	500 in-lb	600 in-lb	1,000 in-lb	1,200 in-lb
Maximum Speed	15,000 RPM	15,000 RPM	15,000 RPM	15,000 RPM	15,000 RPM	15,000 RPM
Overload Limit	300 in-lb	600 in-lb	1,500 in-lb	1,800 in-lb	3,000 in-lb	3,600 in-lb
Torsional Stiffness	13,500 in-lb/radian	33,000 in-lb/radian	94,000 in-lb/radian	120,000 in-lb/radian	204,000 in-lb/radian	204,000 in-lb/radian
Non-Linearity	≤0.05 % FS	≤0.05 % FS	≤0.05 % FS	≤0.05 % FS	≤0.05 % FS	≤0.05 % FS
Hysteresis	≤0.05 % FS	≤0.05 % FS	≤0.05 % FS	≤0.05 % FS	≤0.05 % FS	≤0.05 % FS
Typical Applications	Well-suited for higher speed operation in demanding test and measurement applications					

ROTARY TRANSFORMER						
Model Number	4115K-08A	4115K-09A	4115K-10A	4115K-11A	4115K-12A	4115K-13A
Sensitivity	2.5 mV/V	2.5 mV/V	2.5 mV/V	2.5 mV/V	2.5 mV/V	2.5 mV/V
Measurement Range	2,000 in-lb	2,400 in-lb	3,600 in-lb	5,000 in-lb	6,000 in-lb	10,000 in-lb
Maximum Speed	15,000 RPM	15,000 RPM	15,000 RPM	15,000 RPM	15,000 RPM	15,000 RPM
Overload Limit	6,000 in-lb	7,200 in-lb	10,800 in-lb	15,000 in-lb	15,000 in-lb	15,000 in-lb
Torsional Stiffness	204,000 in-lb/radian	380,000 in-lb/radian	420,000 in-lb/radian	500,000 in-lb/radian	500,000 in-lb/radian	500,000 in-lb/radian
Non-Linearity	≤0.05 % FS	≤0.05 % FS	≤0.05 % FS	≤0.05 % FS	≤0.05 % FS	≤0.05 % FS
Hysteresis	≤0.05 % FS	≤0.05 % FS	≤0.05 % FS	≤0.05 % FS	≤0.05 % FS	≤0.05 % FS
Typical Applications	Well-suited for higher speed operation in demanding test and measurement applications					



ROTARY TRANSFORMER TORQUE SENSOR					
Model Number	4103-01A	4103-02A	4104-01A	4104-02A	4104-03A
Sensitivity	2 mV/V	2 mV/V	2.5 mV/V	2.5 mV/V	2.5 mV/V
Measurement Range	100 in-lb	200 lbf-in	500 lbf-in	1,000 lbf-in	2,000 lbf-in
Maximum Speed	15,000 RPM	15,000 RPM	15,000 RPM	15,000 RPM	15,000 RPM
Overload Limit	300 in-lb	600 in-lb	1,500 in-lb	3,000 in-lb	3,000 in-lb
Torsional Stiffness	13,500 in-lb/radian	33,000 in-lb/radian	85,000 in-lb/radian	150,000 in-lb/radian	150,000 in/radian
Non-Linearity	≤0.05 % FS	≤0.05 % FS	≤0.05 % FS	≤0.05 % FS	≤0.05 % FS
Hysteresis	≤0.05 % FS	≤0.05 % FS	≤0.05 % FS	≤0.05 % FS	≤0.05 % FS

ROTARY TRANSFORMER TORQUE SENSOR						
Model Number	4105-01A	4105-02A	4105-03A	4106-01A	4106-02A	4106-03A
Sensitivity	2.5 mV/V	2.5 mV/V	2.5 mV/V	2 mV/V	2 mV/V	2 mV/V
Measurement Range	5,000 in-lb	5,000 in-lb	10,000 in-lb	10,000 in-lb	20,000 in-lb	36,000 in-lb
Maximum Speed	12,000 RPM	12,000 RPM	12,000 RPM	6,700 RPM	6,700 RPM	6,700 RPM
Overload Limit	6,000 in-lb	15,000 in-lb	15,000 in-lb	30,000 in-lb	60,000 in-lb	60,000 in-lb
Torsional Stiffness	700 kin-lb/radian	900 kin-lb/radian	950 kin-lb/radian	4,100 kin-lb/radian	11,800 kin-lb/radian	11,800 kin-lb/radian
Non-Linearity	≤0.05 % FS	≤0.05 % FS	≤0.05 % FS	≤0.05 % FS	≤0.05 % FS	≤0.05 % FS
Hysteresis	≤0.05 % FS	≤0.05 % FS	≤0.05 % FS	≤0.05 % FS	≤0.05 % FS	≤0.05 % FS



ROTARY SLIP RING TORQUE SENSOR				
Model Number	3122-01A	3122-02A	3122-03A	3122-04A
Sensitivity	1.5 mV/V	1.5 mV/V	1.5 mV/V	1.5 mV/V
Measurement Range	8.85 in-lb	17.7 in-lb	50 in-lb	88.5 in-lb
Maximum Speed	10,000 RPM	10,000 RPM	10,000 RPM	10,000 RPM
Overload Limit	44 in-lb	71 in-lb	133 in-lb	177 in-lb
Torsional Stiffness	400 in-lb/radian	1,100 in-lb/radian	4,400 in-lb/radian	12,400 in-lb/radian
Non-Linearity	≤0.10 % FS	≤0.10 % FS	≤0.10 % FS	≤0.10 % FS
Hysteresis	≤0.10 % FS	≤0.10 % FS	≤0.10 % FS	≤0.10 % FS



ROTARY SLIP RING TORQUE SENSOR							
Model Number	3123-01A	3123-02A	3124-01A	3124-02A	3124-03A	3125-01A	3125-02A
Sensitivity	2 mV/V	2 mV/V	2 mV/V	2 mV/V	2 mV/V	2 mV/V	2 mV/V
Measurement Range	100 in-lb	200 in-lb	500 in-lb	1,000 in-lb	2,000 in-lb	5,000 in-lb	10,000 in-lb
Maximum Speed	7,900 RPM	7,900 RPM	7,900 RPM	7,900 RPM	7,900 RPM	7,900 RPM	5,000 RPM
Overload Limit	200 in-lb	400 in-lb	1,000 in-lb	2,000 in-lb	4,000 in-lb	10,000 in-lb	20,000 in-lb
Non-Linearity	≤0.10 % FS	≤0.10 % FS	≤0.10 % FS	≤0.10 % FS	≤0.10 % FS	≤0.10 % FS	≤0.10 % FS
Hysteresis	≤0.10 % FS	≤0.10 % FS	≤0.10 % FS	≤0.10 % FS	≤0.10 % FS	≤0.10 % FS	≤0.10 % FS

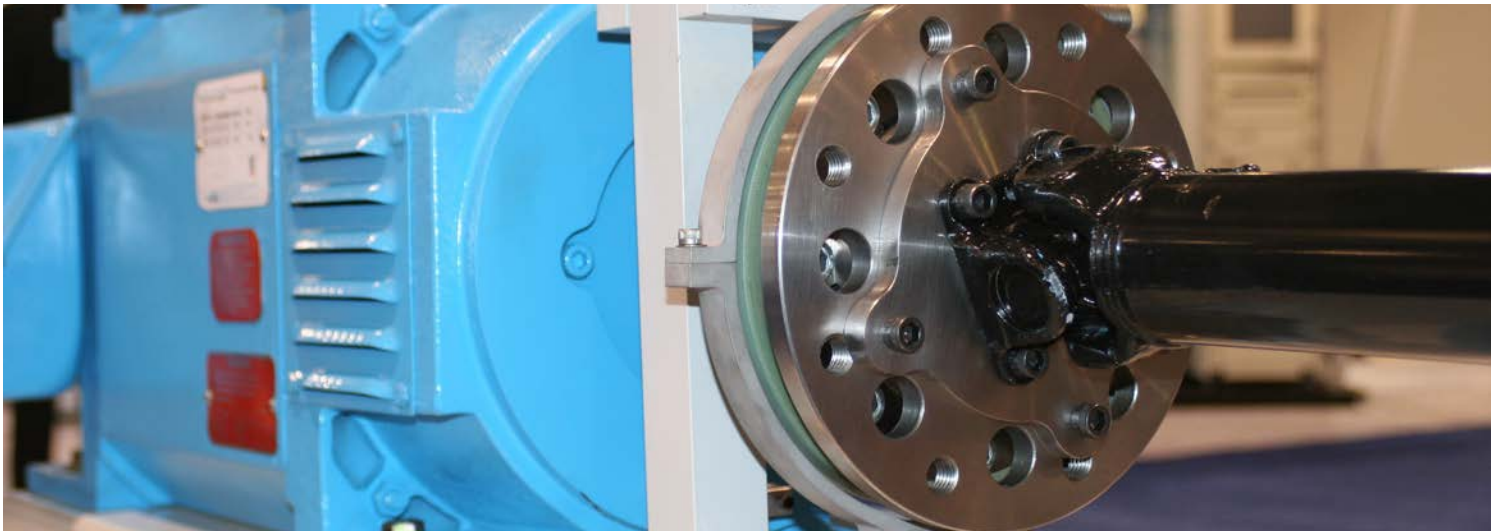

## TORKDISC®

The TORKDISC® is a short-coupled, torsionally stiff structure that is ideal for a wide range of applications requiring high-accuracy, in-line rotary torque measurements. The sensor consists of a spring element which is torsionally loaded as torque is applied between an inner and outer mounting surface. Male and female pilots are provided to ensure good concentricity as the TORKDISC® is bolted into a driveline. Torque is transmitted by friction created between the mounting surfaces of the TORKDISC® and customer-provided mounting fixtures. Sixteen-bit digital telemetry signal transmission provides noise-free operation.



TORKDISC TELEMETRY SYSTEM						
Model Number	5302D-03A	5302D-01A	5302D-02A	5308D-01A	5308D-02A	5308D-03A
Measurement Range	1,000 in-lb	2,000 in-lb	5,000 in-lb	10,000 in-lb	20,000 in-lb	30,000 in-lb
Accuracy	±0.10 % FS	±0.10 % FS	±0.10 % FS	±0.10 % FS	±0.10 % FS	±0.10 % FS
Maximum Speed	15,000 RPM	15,000 RPM	15,000 RPM	10,000 RPM	10,000 RPM	10,000 RPM
Overload Limit (Safe)	3,000 in-lb	6,000 in-lb	15,000 in-lb	30,000 in-lb	60,000 in-lb	75,000 in-lb
Torsional Stiffness	2,900 kin-lb/radian	5,800 kin-lb/radian	14,500 kin-lb/radian	33,500 kin-lb/radian	67,000 kin-lb/radian	100,000 kin-lb/radian
Typical Applications	Ideal for testing that requires a robust rotary torque transducer, and for applications in which axial space is at a premium.					

TORKDISC TELEMETRY SYSTEM				
Model Number	5309D-01A	5309D-02A	5310D-01A	5310D-04A
Measurement Range	50,000 in-lb	100,000 in-lb	180,000 in-lb	225,000 in-lb
Accuracy	±0.10 % FS	±0.10 % FS	±0.10 % FS	±0.10 % FS
Maximum Speed	10,000 RPM	10,000 RPM	4,500 RPM	4,500 RPM
Overload Limit (Safe)	100,000 in-lb	200,000 in-lb	540,000 in-lb	675,000 in-lb
Torsional Stiffness	115,000 kin-lb/radian	230,000 kin-lb/radian	110,000 in-lb/radian	13,500,000 in-lb/radian
Typical Applications	Ideal for testing that requires a robust rotary torque transducer, and for applications in which axial space is at a premium.			

## SPEED SENSORS

Speed sensors may be used with rotary torque sensors to provide a measurement of rotational speed. Horsepower can then be calculated using the speed and torque measurements by the following relationship:

$$HP = \text{Torque (in-lbs)} \times \text{RPM} / 63025$$

These devices install into ports provided on Series 4100 torque sensors. The output of a speed sensor switches in the presence of ferromagnetic material such as steel gear teeth. Output amplitude and wave-form are affected by gear speed and tooth shape.

Speed sensor gears are usually made with 60 teeth. A speed sensor used with a 60 tooth gear will have an output of 100 Hz for a shaft speed of 100 RPM.



SPEED SENSORS	
Model Number	Description
A-30775-1A	Active speed sensor kit, 0 to 20k Hz, incl. mating connector (180-021A / MS3106A-10SL-3S) and cable clamp (180-018A / MS3057-4)
A-30774A	Passive speed sensor kit, 200 to 20k Hz, incl. mating connector (180-017A / MS3106A-10SL-4S) and cable clamp (180-018A / MS3057-4)

## PEDAL FORCE TRANSDUCER

PEDAL FORCE TRANSDUCER		
Model Number	1515-110-03A	1515-110-05A
Sensitivity	2.00 mV/V	3.30 mV/V
Measurement Range	300 lbf	500 lbf
Overload Limit	600 lbf	750 lbf
Non-Linearity	≤0.20 % FS	≤0.20 % FS
Hysteresis	≤0.30 % FS	≤0.30 % FS
Typical Applications	Automotive fatigue testing	





## CABLE ASSEMBLIES

Standard lengths include 5, 10, 20 & 50 feet. "xx" indicates length in feet.

CABLE ASSEMBLIES	
Model Number	Description
8311-01-xxA	Sensors with PT conn., PT06A-10-6S to pigtails, 4-cond. cable
8315-01-xxA	Sensors with PC conn., PC06W-10-6S to pigtails, 4-cond. cable
8310-06-xxA	Series 4100 w/ Series 8120, MS3106F-14S-5S to card edge conn., 6-cond. cable
8310-03-xxA	Series 4100, MS3106F-14S-5S to pigtails, 6-cond. cable
Reaction Torque and Load Cells with PT connector <20 ft	
8311-04-xxA	8120 Series, PT06A-10-6S to card edge conn., 4-cond. cable
8311-17-xxA	8159 Series, PT06A-10-6S to 9-pin(M) D-sub conn., 4-cond. cable
8311-01-xxA	8162 Series, PT06A-10-6S to pigtails, 4-cond. cable
Load Cells with PC connector <20 ft	
8315-04-xxA	8120 Series, PC06W-10-6S to card edge conn., 4-cond. cable
8315-17-xxA	8159 Series, PC06W-10-6S to 9-pin(M) D-sub conn., 4-cond. cable
8315-01-xxA	8162 Series, PC06W-10-6S to pigtails, 4-cond. cable
Reaction Torque and Load Cells with PT connector >=20 ft	
8311-05-xxA	8120 Series, PT06A-10-6S to card edge conn., 8-cond. cable
8311-18-xxA	8159 Series, PT06A-10-6S to 9-pin(M) D-sub conn., 8-cond. cable
8311-02-xxA	8162 Series, PT06A-10-6S to pigtails, 8-cond. cable
Load Cells with PC connector >=20 ft	
8315-05-xxA	8120 Series, PC06W-10-6S to card edge conn., 8-cond. cable
8315-18-xxA	8159 Series, PC06W-10-6S to 9-pin(M) D-sub conn., 8-cond. cable
8315-02-xxA	8162 Series, PC06W-10-6S to pigtails, 8-cond. cable
Special Cables	
8314-21-xxA	8159 Series, 15-pin(M) D-sub conn. to pigtails, 4-cond. cable
8312-01-xxA	Passive Speed Sensor, 97-3106A-10SL-4S to pigtails, 2-cond. cable
8312-02-xxA	Passive Speed Sensor, 97-3106A-10SL-4S to card edge conn., 2-cond. cable
8313-03-xxA	Active Speed Sensor, 97-3106A-10SL-3S to pigtails, 4-cond. cable
8313-04-xxA	Active Speed Sensor, 97-3106A-10SL-4S to card edge conn., 4-cond. cable
MATING CONNECTORS	
Model Number	Description
181-012A	PT06A-10-6S (SR)
182-025A	PC06A-10-6S (SR)
182-026A	9-pin(M) D-sub Connector & Backshell
182-027A	15-pin(M) D-sub Connector & Backshell



Series 8159, 8161, and 8162 signal conditioners are offered for use with strain gage load cells and reaction torque sensors. These units provide the necessary, regulated excitation voltage and deliver conditioned output signals for recording, control, or analysis purposes.

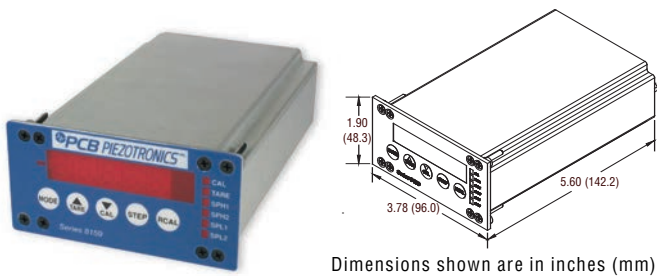

Dimensions shown are in inches (mm)

## DIGITAL FORCE INDICATOR / CONTROLLER

MODEL 8159

- Operates from 115 or 230 VAC power
- Provides 5 or 10 VDC strain gage bridge excitation
- Delivers  $\pm 10$  Volts and 4 to 20 mA output signals
- 5-digit, red LED display with 1/8 DIN panel mounting
- 4 programmable set points with LED status indicators
- Easy, menu-driven setup
- Optional RS-232 output

HOW TO ORDER	
<b>Base Model</b>	
<b>8159</b>	115 VAC Powered Indicator with Transducer Excitation Prefix for 230 VAC Powered Version (internal jumper selectable)
<b>Communications</b>	
0	None
1	RS-232 (transmit only)
<b>Sense Leads (internal jumper selectable)</b>	
0	Disabled
1	Enabled (recommended for cables >20 ft (6.1 m))
<b>Bridge Excitation (internal jumper selectable)</b>	
1	10 VDC
5	5 VDC
<b>Full-scale Input (internal switch selectable)</b>	
1	1.5 mV/V
2	2.5 mV/V
3	3.5 mV/V
<b>Version Code</b>	
A	Initial Release
<b>Example</b>	
8159-	0 0 1 2 A Strain gage signal conditioner with $\pm 10$ Volts and 4 to 20 mA output signals, 10 VDC bridge excitation, and calibrated in voltage.



## SIGNAL CONDITIONERS FOR USE WITH LOAD CELLS

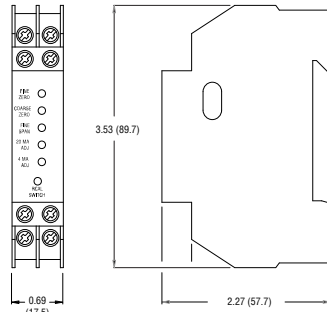

Dimensions shown are in inches (mm)

### DIN RAIL MOUNT SIGNAL CONDITIONER

MODEL 8161

- Operates from 12 to 28 VDC power
- Provides 5 or 10 VDC strain gage bridge excitation
- Delivers  $\pm 5$  or  $\pm 10$  Volts and 4 to 20 mA output signals
- Built-in, switch-actuated, shunt calibration

#### HOW TO ORDER

##### Base Model

**8161** DIN Rail Mount Strain Gage Signal Conditioner

##### Calibrated Output Signal

0 Voltage

1 Current

##### Output Signals (internal jumper selectable)

1  $\pm 10$  Volts and 4 to 20 mA

5  $\pm 5$  Volts and 4 to 20 mA

##### Bridge Excitation (internal jumper selectable)

1 10 VDC

5 5 VDC

##### Version Code

A Initial Release

##### Example

8161- 0 1 1 A

DIN rail mount strain gage signal conditioner, +/- 10 V & 4 to 20 mA outputs, calibrated in voltage, 10 VDC bridge excitation voltage, switch activated shunt, 12 to 28 VDC operation



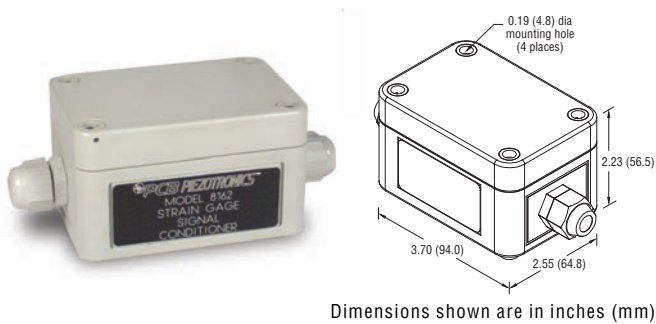

Dimensions shown are in inches (mm)

## IN-LINE STRAIN GAGE SIGNAL CONDITIONER

MODEL 8162

- Operates from 12 to 28 VDC power
- Provides 5 or 10 VDC strain gage bridge excitation
- Delivers  $\pm 5$  or  $\pm 10$  Volts and 4 to 20 mA output signals
- Built-in, switch-actuated, shunt calibration
- IP66 (NEMA 4X) enclosure
- Screw terminal connections

HOW TO ORDER					
Base Model					
<b>8162</b>	Strain Gage Signal Conditioner				
<b>Calibrated Output Signal</b>					
0	Voltage				
1	Current				
<b>Output Signals (internal jumper selectable)</b>					
1	$\pm 10$ Volts and 4 to 20 mA				
5	$\pm 5$ Volts and 4 to 20 mA				
<b>Bridge Excitation (internal jumper selectable)</b>					
1	10 VDC				
5	5 VDC				
<b>Version Code</b>					
A	Initial Release				
Example					
8162-	0	1	1	A	Strain gage signal conditioner with $\pm 10$ Volts and 4 to 20 mA output signals, 10 VDC bridge excitation, and calibrated in voltage.

## ROD ENDS

Rod ends are designed to maintain tension loading alignment between a load cell and a mounting surface.

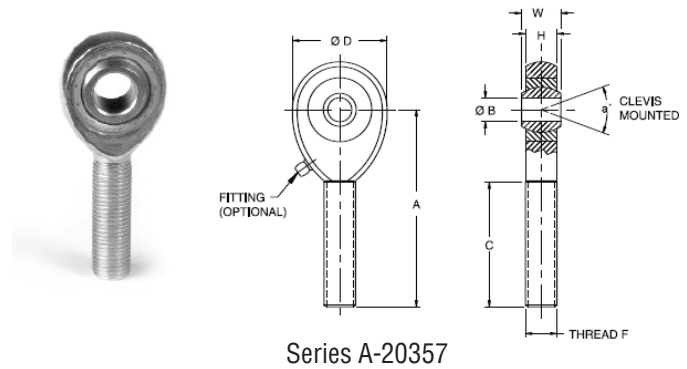

Series A-20357

ROD ENDS										
Model Number	Thread (UNF-3B)	Dimensions - Inches (mm)							Static Load	Weight
	T	B	W	H	A	D	C	a (deg.)	lb (N)	lb (g)
A-20357-1A	1/4-28	0.25 (5.1)	0.38 (9.5)	0.281 (7.14)	1.56 (39.6)	0.75 (19.1)	1.0 (25.4)	16	2150 (9600)	0.04 (18)
A-20357-2A	3/8-24	0.38 (9.5)	0.50 (12.7)	0.406 (10.3)	1.94 (49.3)	1.0 (25.4)	1.25 (31.8)	12	5300 (23k)	0.25 (113)
A-20357-3A	1/2-20	0.50 (12.7)	0.63 (15.9)	0.5 (12.7)	2.44 (62)	1.312 (33.3)	1.5 (38.1)	12	23k (100k)	0.25 (113)
A-20357-4A	5/8-18	0.63 (15.9)	0.75 (19.1)	0.562 (14.3)	2.63 (66.8)	1.5 (38.1)	1.625 (41.4)	16	31k (135k)	0.38 (172)
A-20357-5A	3/4-16	0.75 (19.1)	0.88 (22.2)	0.687 (17.5)	2.88 (73.2)	1.75 (44.5)	1.75 (44.5)	14	40k (180k)	0.6 (272)
A-20357-6A	1-14	1.00 (25.4)	1.38 (34.9)	1.0 (25.4)	4.13 (104.9)	2.75 (69.9)	2.125 (54.1)	17	43k (190k)	2.1 (953)
A-20357-7A	1 1/4-12	1.00 (25.4)	1.38 (34.9)	1.0 (25.4)	4.13 (104.9)	2.75 (69.9)	2.125 (54.1)	17	44k (195k)	2.4 (1089)

## LOAD BUTTONS

Load buttons are designed to direct applied forces to the measuring axis of a load cell used in compression.

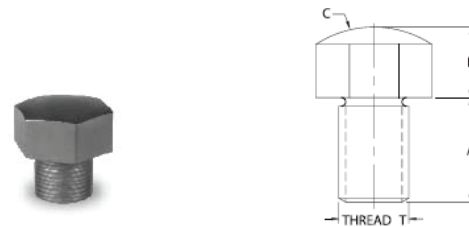

Series C-20099

LOAD BUTTON				
Model Number	Thread (UNF-3A)	Dimensions - Inches (mm)		
	T	A	B	C
C-20099-1A	1/4-28	0.37 (9.4)	0.25 (6.35)	0.75 (19.1)
C-20099-2A	3/8-24	0.5 (12.7)	0.375 (9.53)	2.0 (50.8)
C-20099-3A	1/2-20	0.62 (15.7)	0.5 (12.7)	2.0 (50.8)
C-20099-4A	5/8-18	0.62 (15.7)	0.5 (12.7)	2.0 (50.8)
C-20099-5A	1-14	0.87 (22.1)	0.75 (19.1)	4.0 (101.6)
C-20099-6A	1 1/4-12	1.0 (25.4)	0.75 (19.1)	4.0 (101.6)
C-20099-7A	2 3/4-8	2.5 (63.5)	2.50 (63.5)	6.0 (152.4)
C-20099-8A	3/4-16	0.6 (15.2)	0.3 (7.6)	6.0 (152.4)



## PRINCIPAL OF OPERATION

PCB manufactures a wide variety of Load Cells and Torque Sensors whose electrical output voltage is proportional to the applied force or torque produced by a change in resistance in strain gages, which are bonded to the transducers structure. The magnitude of the change in resistance corresponds to the deformation of the load cell or torsional wind-up and therefore the applied mechanical load.

The four-arm Wheatstone bridge configuration shown in Figure 1 depicts the strain gages geometry used in the PCB Load Cells and Torque Sensor structures. This configuration allows for temperature compensation and cancellation of signals caused by forces not directly applied to the axis of the applied load or torque.

A regulated 5 to 20 volt DC or AC rms excitation is required and is applied between points A and D of the Wheatstone bridge. When a force/torque is applied to the transducer structure, the Wheatstone bridge becomes unbalanced, causing an output voltage between points B and C. This voltage is proportional to the applied load/torque.

Most all PCB Load Cells and Series 2300 Reaction Sensors follow a wiring code established by the Western Regional Strain Gage committee as revised in May 1960, and this code is illustrated in Figure 2a. Series 4100 Rotary Transformer Torque Sensors follow the wiring code illustrated in Figure 2b.

## AXIS DEFINITION

PCB Load Cells and Reaction Torque Sensors comply with the Axis and Sense Definitions of NAS-938 (National Aerospace Standard-Machine Axis and Motion) nomenclature and recommendations of the Western Regional Strain Gage committee.

Axes are defined in terms of a “right handed” orthogonal coordinate system, as shown in Figure 3a & 3b.

For a Load Cell, a tensile load exhibits a positive (+) polarity going output, while a compressive load exhibits a negative (-) polarity going output. The primary axis of rotation or axis of radial symmetry of a Load Cell is the z-axis.

A Torque Transducer’s principal axis is normally the z-axis. The z-axis will also be the axis of radial symmetry or axis of rotation. In the event there is no clearly defined axis, the following preference system will be used: z, x, y.

A Rotary Torque Sensors axis and sense nomenclature is shown in Figure 4. A (+) positive sign indicates torque in a direction which produces a (+) positive signal voltage and generally defines a clockwise torque.

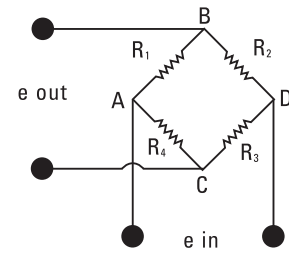

Figure 1: Wheatstone Bridge

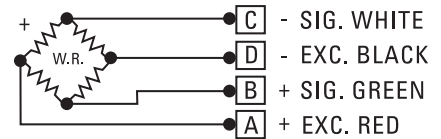

Figure 2a: Wiring Code

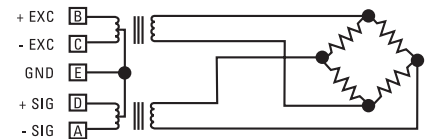

Figure 2b: Wiring Code

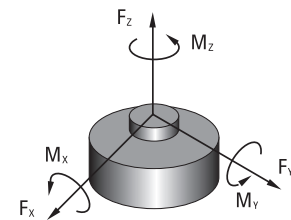

Figure 3a: Right-handed Orthogonal Coordinate System

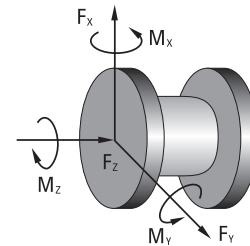

Figure 3b: Right-handed Orthogonal Coordinate System

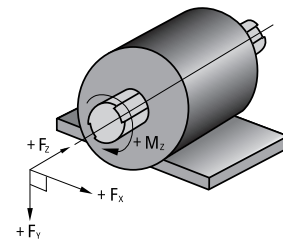

Figure 4: Axis and Sense Nomenclature for Torque Sensors

# TYPICAL MEASUREMENT SYSTEM

---

## SERIES 2300 AND 2500 REACTION TORQUE SENSOR

All PCB reaction torque sensors utilize strain gages that are configured in a Wheatstone bridge as their primary sensing element. The resistance value of the strain gages changes when torsional load is applied to the sensing structure and consequently, any voltage through the bridge circuit will be varied. The Wheatstone bridge requires a regulated DC voltage excitation that is commonly provided by a strain gage signal conditioner. The resultant output signal from the torque sensor is typically expressed in units of millivolt per volt of excitation. This millivolt signal then varies proportionately to the applied torque. The strain gage signal conditioner provides zero and span adjustments to scale its 0 to 5 VDC analog output to be proportional to any desired input range.

Reaction torque sensors are provided with an electrical connector, and cable assemblies are necessary to interface this connection to the strain gage signal conditioner. Two types of cable are commonly available, and their use is dependent upon signal transmission distance. Cable assemblies may be selected with a terminating connector, which makes it easier to connect to a PCB strain gage signal conditioner, or with a pigtail termination that allows connection to screw terminal connections on other styles of strain gage signal conditioners.

## SERIES 4100 ROTARY TORQUE SENSOR

Rotary torque sensors utilize strain gages that are configured in a Wheatstone bridge as their primary sensing element. The resistance value of the strain gages changes when torsional load is applied to the sensing structure and consequently, any voltage through the bridge circuit will be varied. The Wheatstone bridge requires a regulated AC voltage excitation that is commonly provided by a strain gage signal conditioner. The resultant output signal from the torque sensor is typically expressed in units of millivolt per volt of excitation. This millivolt signal then varies proportionately to the applied torque. The strain gage signal conditioner provides zero and span adjustments to scale its 0 to 5 VDC analog output to be proportional to any desired input range.

Most rotary torque sensors can accommodate an optional speed sensor to facilitate monitoring of the revolutions-per-minute of the system or for horsepower calculations. Speed sensors are Hall Effect devices whose output varies as a gear tooth passes its sensitive face. A typical speed gear within a rotary torque sensor will possess 60 teeth in order to provide 60 pulses per revolution of output from the speed sensor. Speed sensors require a DC excitation voltage that is commonly provided by a Hall Effect sensor signal conditioner.

Rotary torque sensors are provided with an electrical connector, and cable assemblies are necessary to interface this connection to the strain gage signal conditioner. Optional speed sensors incorporate their own electrical connector and will require a separate cable assembly and signal conditioner. Cable assemblies may be selected with a terminating connector, which makes it easier to connect to PCB's strain gage and Hall Effect signal conditioners, or with a pigtail termination that allows connection to screw terminal connections on other styles of strain gage and Hall Effect signal conditioners.

REACTION TORQUE SENSOR						
	Small Capacity Flange Mount	Flange Mount				
Size (dia x length) - in	2 x 3	4 x 3	5 x 3.5	8 x 7.38	9.75 x 8.5	14 x 10.5
Size (dia x length) - cm	5.08 x 7.62	10.16 x 7.62	12.7 x 8.89	20.32 x 18.75	24.77 x 21.59	35.56 x 26.67
Flange Dia B.C - in	1.25	3.25	4.25	6.5	8	11
Flange Dia B.C. - cm	3.18	8.26	10.8	16.51	20.32	27.94
Connector	6-pin PT	6-pin PT	6-pin PT	6-pin PT	6-pin PT	6-pin PT
Capacity	Model Number					
50 in-lb (5.6 N-m)	2508-01A					
100 in-lb (11 N-m)	2508-02A					
200 in-lb (23 N-m)	2508-03A					
500 in-lb (57 N-m)	2508-04A					
1000 in-lb (113 N-m)	2508-05A					
2000 in-lb (226 N-m)		2301-01A				
5000 in-lb (565 N-m)		2301-02A				
10k in-lb (1130 N-m)			2302-01A			
20k in-lb (2259 N-m)			2302-02A			
50k in-lb (5649 N-m)				2303-01A		
100k in-lb (11.3k N-m)				2303-02A	2304-01A	
200k in-lb (22.6k N-m)					2304-02A	
300k in-lb (33.9k N-m)						2305-01A
500k in-lb (56.5k N-m)						2305-02A

TORKDISC®				
	Flange Mount			
Rotor Size (dia x thk) - in	7.00 x 1.10	8.49 x 1.10	9.49 x 1.64	17.98 x 2.09
Rotor Size (dia x thk) - cm	17.78 x 2.79	21.59 x 2.79	24.13 x 4.17	45.72 x 5.31
Receiver Size (l x w x h) - in	7.17 x 7.46 x 1.92	7.17 x 7.46 x 1.92	7.17 x 7.46 x 1.92	7.17 x 7.46 x 1.92
Receiver Size (l x w x h) - cm	18.21 x 18.95 x 4.88	18.21 x 18.95 x 4.88	18.21 x 18.95 x 4.88	18.21 x 18.95 x 4.88
Capacity	Model Number			
1000 in-lb (113 N-m)	5302D-03A*			
2000 in-lb (226 N-m)	5302D-01A*			
5000 in-lb (565 N-m)	5302D-02A			
10k in-lb (1130 N-m)		5308D-01A		
20k in-lb (2260 N-m)		5308D-02A		
30k in-lb (3390 N-m)		5308D-03A		
50k in-lb (5649 N-m)			5309D-01A	
100k in-lb (11.3k N-m)			5309D-02A	
180k in-lb (20.3k N-m)				5310D-01A
225k in-lb (25.4 N-m)				5310D-04A

\*Denotes aluminum models. All other models are steel.

ROTARY TRANSFORMER TORQUE SENSOR				
	Keyed Shaft Ends			
Size (dia x length) - in	4 x 10	4 x 10	4.8 x 12.75	5.5 x 15.75
Size (dia x length) - cm	10.16 x 25.4	10.16 x 25.4	12.19 x 32.39	13.97 x 40
Shaft Dia. - in	0.75	1	1.5	2.25
Shaft Dia. - cm	1.91	2.54	3.81	5.72
Connector	5-pin MS	5-pin MS	5-pin MS	5-pin MS
Capacity	Model Number			
100 in-lb (11 N-m)	4103-01A			
200 in-lb (23 N-m)	4103-02A			
500 in-lb (56.5 N-m)		4104-01A		
1000 in-lb (113 N-m)		4104-02A		
2000 in-lb (226 N-m)		4104-03A	4105-01A	
5000 in-lb (585 N-m)			4105-02A	
10k in-lb (1130 N-m)			4105-03A	4106-01A
20k in-lb (2260 N-m)				4106-02A
36k in-lb (4067 N-m)				4106-03A

ROTARY TRANSFORMER TORQUE SENSOR		
	Flange Mount	
Size (dia x length) - in	6 x 9.35	6 x 9.94
Size (dia x length) - cm	15.24 x 23.75	15.24 x 25.25
Shaft Dia. - in	1.58	1.58
Shaft Dia. - mm	4	4
Number of teeth	16	24
Flange Dia B.C. - in	5	5
Flange Dia B.C. - cm	12.7	12.7
Connector	5-pin MS	5-pin MS
Capacity	Model Number	
100 in-lb (11 N-m)	4115A-02A	4115K-02A
200 in-lb (23 N-m)	4115A-03A	4115K-03A
500 in-lb (55 N-m)	4115A-04A	4115K-04A
600 in-lb (68 N-m)		4115K-05A
1000 in-lb (115 N-m)	4115A-05A	4115K-06A
1200 in-lb (135 N-m)		4115K-07A
2000 in-lb (225 N-m)		4115K-08A
2400 in-lb (270 N-m)		4115K-09A
3600 in-lb (405 N-m)		4115K-10A
5000 in-lb (565 N-m)		4115K-11A
6000 in-lb (675 N-m)		4115K-12A
10k in-lb (1130 N-m)		4115K-13A

GENERAL PURPOSE CANISTER LOAD CELLS	
Size (dia x length) - in	2.75 x 1.5
Size (dia x length) - cm	89.9 x 38.1
Thread	1/4-28
Connector	6-pin PT
Capacity	Model Number
25 lb (111 N)	1102-05A
50 lb (222 N)	1102-01A*
100 lb (445 N)	1102-02A*
200 lb (890 N)	1102-03A*
300 lb (1334 N)	1102-04A*

\* Aluminum load cells (low weight). All other models are steel.



GENERAL PURPOSE LOW PROFILE LOAD CELLS		
Size (dia x length) - in	4.12 x 1.37	6.06 x 1.75
Size (dia x length) - mm	104.6 x 34.8	153.9 x 44.5
Thread	5/8-18	1 1/4-12
Connector	6-pin PT	6-pin PT
Capacity	Model Number	
500 lb (2224 N)	1203-11A	
1000 lb (4448 N-m)	1203-12A	
2000 lb (8896 N-m)	1203-13A	
5000 lb (22.2k N)	1203-14A	
10k lb (44k N)	1203-15A	
25k lb (111k N)		1204-12A
50k lb (222k N)		1204-13A

FATIGUE-RATED LOW PROFILE LOAD CELLS		
Size (dia x height) - in	4.12 x 1.37	6.06 x 1.75
Size (dia x height) - mm	104.6 x 34.8	153.9 x 44.5
Thread	5/8-18	1 1/4-12
Connector	6-pin PT	6-pin PT
Capacity	Model Number	
250 lb (1112 N)	1403-11A	
500 lb (2225 N)	1403-12A	
1000 lb (4448 N)	1403-13A	
2500 lb (11 kN)	1403-14A	
5000 lb (22k N)	1403-15A	
12.5k lb (56k N)		1404-12A
25k lb (111k N)		1404-13A



